

VIP-Fool proof fork head shackle VVGSCHE 10

Artikel-Nr: 7102024



High tensile version with an integrated safety thread in the shackle bracket. Smooth bolt support in the shackle on both sides. The bolt is turnable. No bending strength in the thread (only a securing function). Optimal adaptation - max. mouth width with the smallest shackle bolt. Owing to the turned clevis connection, it is extensively resistant to bending. Long term securing by driving in the pre-assembled tensioning sleeve. Special thread, thus distinctive in comparison to other shackle bolts. Pre-assembled connecting bolt and tensioning sleeve.

VIP-Fool proof fork head shackle VVG5SCH 10

Artikel-Nr: 7102024

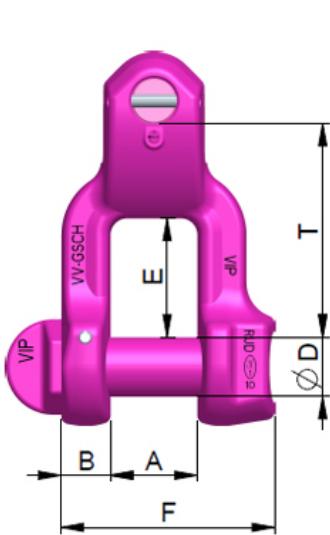

weight	0.60 kg	1.32 lbs
Nominal WLL	4000 kg	8800 lbs
T	60 mm	2-3/8"
A	27 mm	1-1/16"
B	13 mm	1/2"
C	34 mm	1-11/32"
D	16 mm	5/8"
E	35 mm	1-3/8"
F	62 mm	2-7/16"
G	44 mm	1-3/4"