

## Swivel Adapter for Hoists HWA 8 - PK 500

Artikel-Nr: 51293



For Demag-PK 500-hoisting devices. Complete with the original Demag ball bearing. Made of high tensile, quenched and tempered special steel. Tested acc. to EN 1677-1 and BGR 500/DGUV Regel 100-500. Appropriate for single leg snatch blocks and double leg lower blocks. Appropriate for all 8mm - VIP components with a clevis connection.

## Swivel Adapter for Hoists HWA 8 - PK 500

Artikel-Nr: 51293

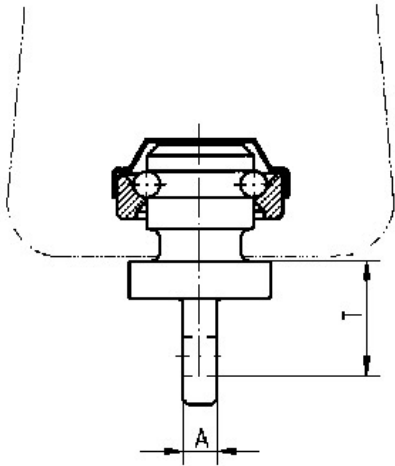

<b>weight</b>	0.28 kg	0.66 lbs
<b>Nominal WLL</b>	500 kg	1100 lbs
<b>T</b>	26 mm	1"
<b>A</b>	8 mm	5/16"